

# VTC12-100 (12V 100AH/20HR) Deep Cycle Lead Carbon Battery

VTC series lead-carbon batteries use functional activated carbon and graphene as carbon materials, which are added to the negative plate of the battery to make lead carbon batteries have the advantages of both lead-acid batteries and super capacitors. It not only improves the ability of rapid charge and discharge, but also greatly prolongs the battery life. It is well suited for PS OC applications.

**12V  
100Ah**

**Carbon  
Technology**

**Long Life  
Battery**



**COMPLIED STANDARDS**

**IEC 60896-21/22  
YD/T799  
GB/T 19638**

**JIS C8704  
BS6290 part4  
CE**

## Applications

- Energy storage system
- Smart power grid and micro grids systems
- Hybrid energy storage system
- RV, golfcart and marine
- Off-grid solar systems

## Dimensions & Weight

Length(mm/inch)	307/12.08
Width(mm/inch)	169/6.65
Height(mm/inch)	211/8.31
Total Height(mm/inch)	216/8.50
Weight(kg/lbs)(±3%)	30.0/66.13

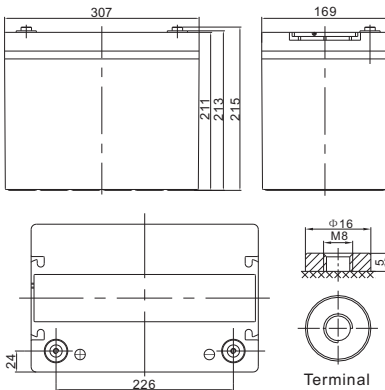

## Battery Discharge Table

## General Features

- Combines the characteristics of a lead acid battery and super capacitor
- Long cycle life design, excellent PSoc and cyclic performance
- High power output, rapid charging and discharging
- Unique grid and lead pasting design
- Extreme temperature tolerance

## Technical Specifications

Nominal Voltage		12V (6 cells per unit)
Design Floating Life @ 25°C		20 Years
Nominal Capacity @ 25°C	20 hour rate@5.0A,10.8V	100Ah
Capacity @ 25°C	10 hour rate (9.0A, 10.8V)	90Ah
	5 hour rate (15.9A, 10.5V)	79.5Ah
	1 hour rate (55.6A, 9.6V)	55.6Ah
Internal Resistance	Full Charged Battery@ 25°C	≤6.5mΩ
Ambient Temperature	Discharge	-30°C~60°C
	Charge	-30°C~60°C
	Storage	-30°C~60°C
Max.Discharge Current @ 25°C		900A(5s)
Capacity affected by Temperature (10 hour )	40°C	108%
	25°C	100%
	0°C	90%
	-15°C	70%
Self-Discharge@25°C per Month		3%
Charge (Constant Voltage) @ 25°C	Standby Use	Initial Charging Current Less than 27.0A Voltage 13.6-13.8V
	Cycle Use	Initial Charging Current Less than 27.0A Voltage 14.4-14.7V

## Discharge Constant Current per Cell (Amperes at 25°C)

F.V/Time	15min	30min	45min	1h	2h	3h	5h	8h	10h	20h	100h
1.60V	128.7	82.0	60.5	55.6	35.3	24.8	16.8	11.1	9.9	5.4	1.20
1.65V	126.4	80.5	59.4	54.5	34.6	24.3	16.5	10.9	9.7	5.3	1.18
1.70V	124.0	79.0	58.3	53.5	34.0	23.9	16.2	10.7	9.5	5.2	1.15
1.75V	121.7	77.5	57.2	52.5	33.3	23.4	15.9	10.5	9.4	5.1	1.13
1.80V	117.0	74.5	55.0	50.5	32.1	22.5	15.3	10.1	9.0	5.0	1.11

## Discharge Constant Power per Cell (Watts at 25°C)

F.V/Time	15min	30min	45min	1h	2h	3h	5h	8h	10h	20h	100h
1.60V	247.7	157.8	116.5	106.9	67.9	47.6	32.4	21.4	19.1	10.4	2.31
1.65V	243.2	154.9	114.3	105.0	66.6	46.8	31.8	21.0	18.7	10.2	2.26
1.70V	238.7	152.0	112.2	103.0	65.4	45.9	31.2	20.6	18.4	10.0	2.22
1.75V	234.2	149.1	110.1	101.1	64.2	45.0	30.6	20.2	18.0	9.8	2.18
1.80V	225.2	143.4	105.9	97.2	61.7	43.3	29.5	19.4	17.3	9.6	2.14

## Performance Characteristics

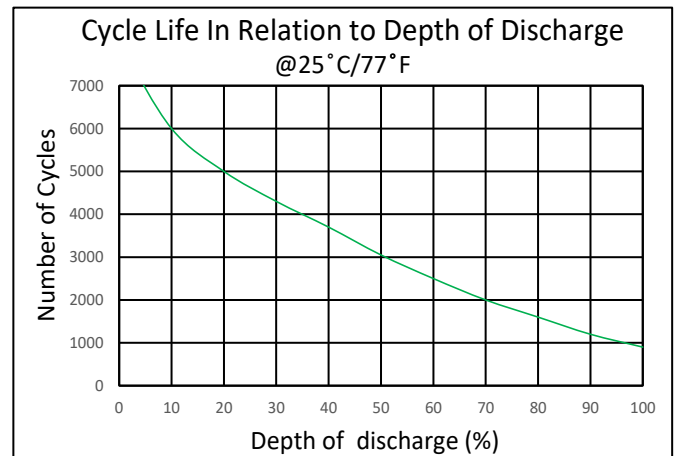
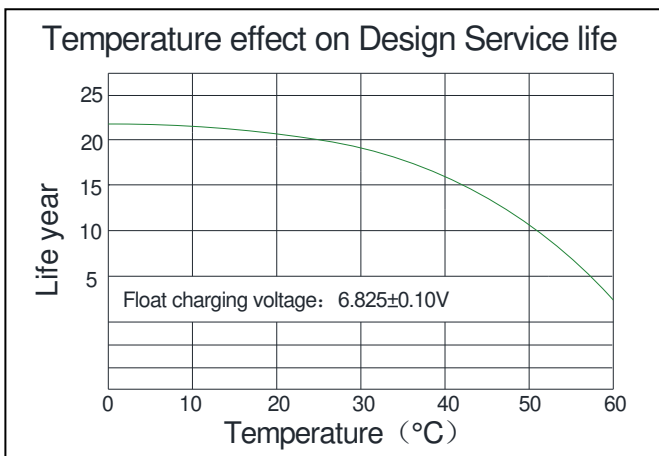
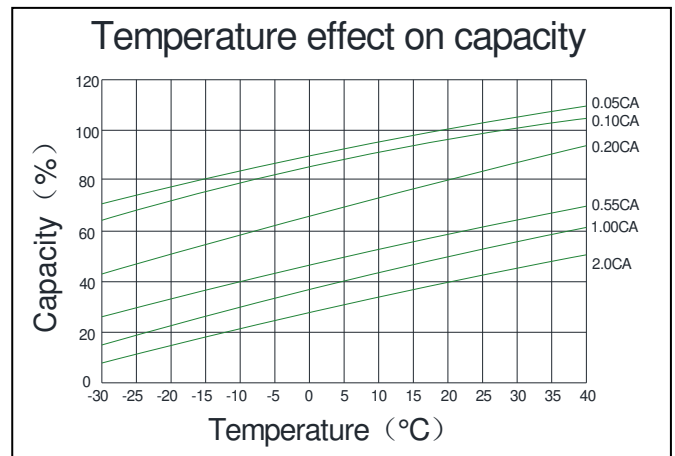
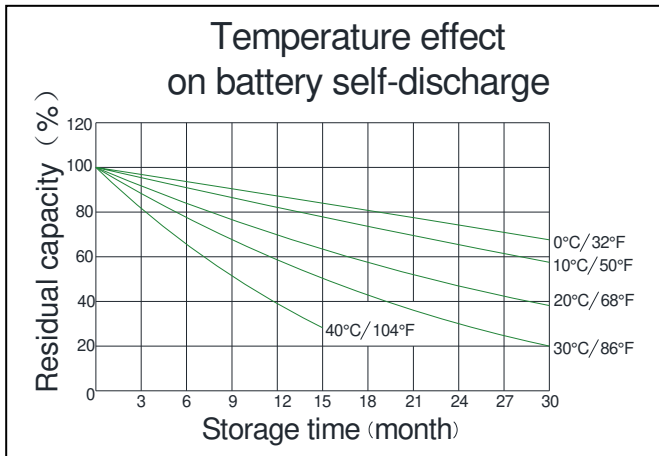
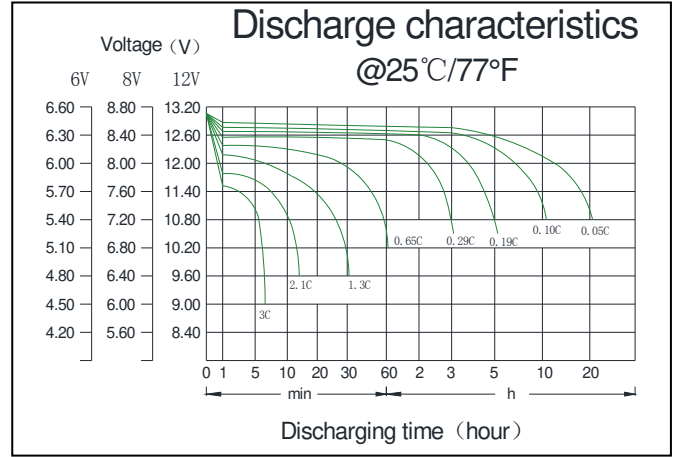
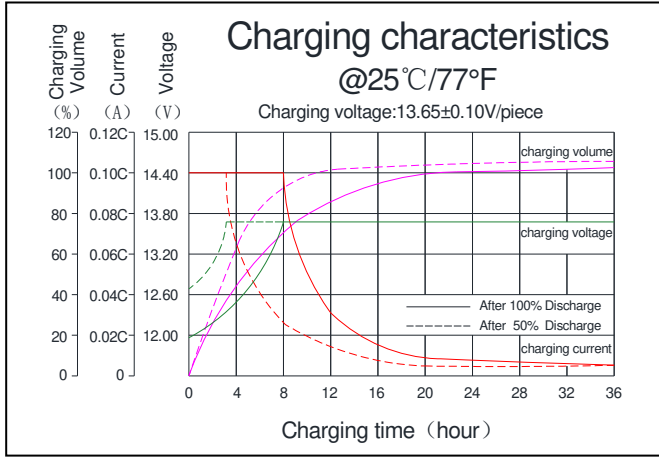

## Battery Construction

Component	Positive Plate	Negative Plate	Container & Cover	Safety Valve	Terminal	Separator	Electrolyte	Pillar Seal
Features	Rare earth alloy grid with good corrosion resistance	Unique anode formula, high purity material, low self-discharge rate	Fire resistant ABS (UL94-V0 optional)	Flame Si-Rubber and aging resistant	Female Copper Insert M8	AGM separator with organic fiber, longer service life	Gradual change gel electrolyte (with patent) /Carbon	Anti-corrosion elastic O ring, two layers epoxy seal technology