



# VTG12-85 (12V 85AH/20HR) High Temperature Deep Cycle GEL Battery

The Valiant VTG series deep cycle Gel battery uses an advanced nano gel electrolyte with Super-C additive and heavy-duty plate design to provide longer service life in deep cycle applications. The VTG series provides optimum and reliable service under extreme temperatures and frequent power failures making it highly suited for out door applications such as off-grid solar systems, RV, and telecom/UPS systems.

**12V  
85Ah**

**GEL  
Technology**

**Deep  
Cycle**



### Applications

- Off-grid solar systems
- RV and Marine
- UPS/Telecom
- Floor Scrubber
- Wheel chair, Golf cart

### General Features

- Operating range of -40 to+ 60 °C
- Deep discharge recovery,1600 cycles @50%DOD
- 2-3 year full warranty in most applications
- Longer life and greater stability in extreme temperatures

### Dimensions & Weight

Length(mm/inch)	260/10.24
Width(mm/inch)	169/6.65
Height(mm/inch)	211/8.31
Total Height(mm/inch)	215/8.46
Weight(kg/lbs)(±3%)	26.4/58.2

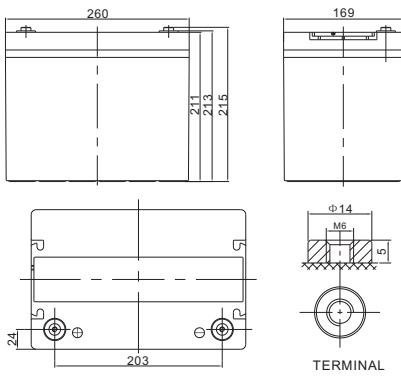

### Technical Specifications

Nominal Voltage		12V (6 cells per unit)
Design Floating Life @ 25°C		15 Years
Nominal Capacity @ 25°C	20 hour rate@4.25A,10.8V	85Ah
Capacity @ 25°C	10 hour rate (7.7A, 10.8V)	77Ah
	5 hour rate (13.5A, 10.5V)	67.5Ah
	1 hour rate (51.9A, 9.6V)	51.9Ah
Internal Resistance	Full Charged Battery@ 25°C	≤6.0mΩ
Ambient Temperature	Discharge	-25°C ~ 60°C
	Charge	-25°C ~ 60°C
	Storage	-25°C ~ 60°C
Max.Discharge Current		@ 25°C 510A(5s)
Capacity affected by Temperature (10 hour )	40°C	108%
	25°C	100%
	0°C	90%
	-15°C	70%
Self-Discharge@25°C per Month		3%
Charge (Constant Voltage) @ 25°C	Standby Use	Initial Charging Current Less than 19.0A Voltage 13.6-13.8V
	Cycle Use	Initial Charging Current Less than 19.0A Voltage 14.4-14.9V

**COMPLIED STANDARDS**  
 IEC 60896-21/22      JIS C8704  
 YD/T799                      BS6290 part4  
 GB/T 19638                      CE

### Battery Discharge Table

#### Discharge Constant Current per Cell (Amperes at 25°C)

F.V/Time	15min	30min	45min	1h	2h	3h	5h	8h	10h	20h	100h
1.60V	137.4	83.7	56.1	51.9	30.0	21.0	14.3	9.4	8.4	4.59	1.02
1.65V	134.9	82.2	55.1	50.9	29.4	20.7	14.0	9.3	8.3	4.51	1.00
1.70V	132.4	80.6	54.1	50.0	28.9	20.3	13.8	9.1	8.1	4.42	0.98
1.75V	129.9	79.1	53.0	49.1	28.3	19.9	13.5	8.9	8.0	4.34	0.96
1.80V	125.0	76.1	51.0	47.2	27.2	19.1	13.0	8.6	7.7	4.25	0.94

#### Discharge Constant Power per Cell (Watts at 25°C)

F.V/Time	15min	30min	45min	1h	2h	3h	5h	8h	10h	20h	100h
1.60V	264.6	161.1	108.0	99.9	57.7	40.5	27.5	18.2	16.2	8.8	1.96
1.65V	259.8	158.2	106.0	98.1	56.6	39.8	27.0	17.8	15.9	8.7	1.93
1.70V	255.0	155.2	104.1	96.3	55.6	39.0	26.5	17.5	15.6	8.5	1.89
1.75V	250.1	152.3	102.1	94.4	54.5	38.3	26.0	17.2	15.3	8.3	1.85
1.80V	240.5	146.4	98.2	90.8	52.4	36.8	25.0	16.5	14.7	8.2	1.82



## Performance Characteristics

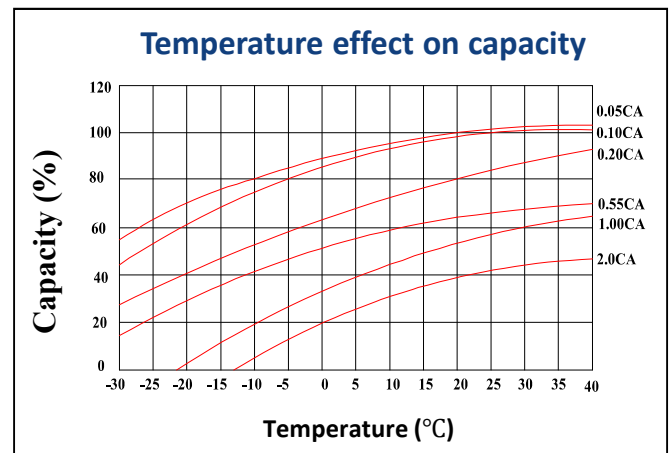
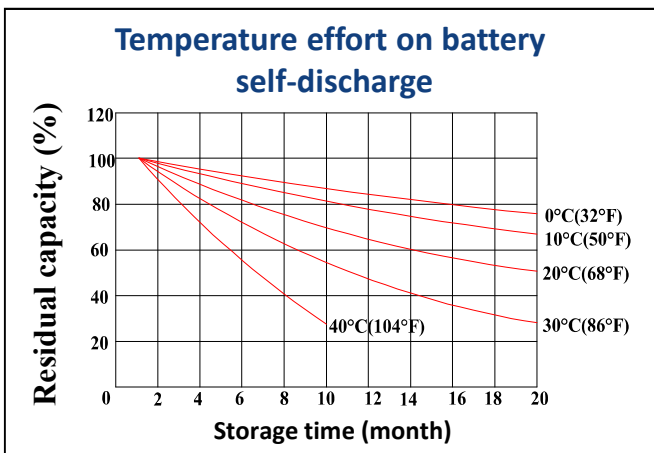
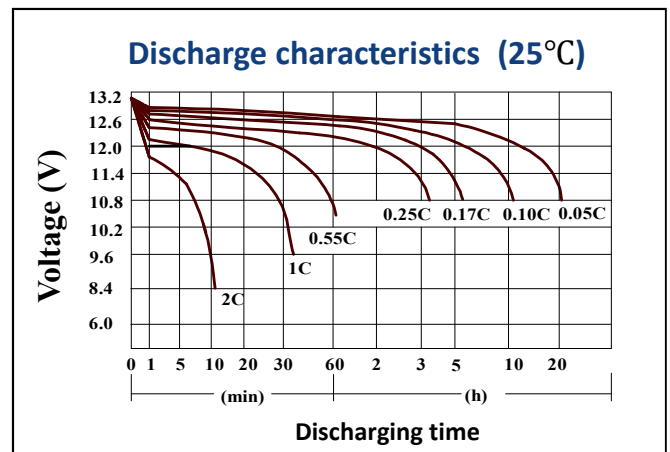
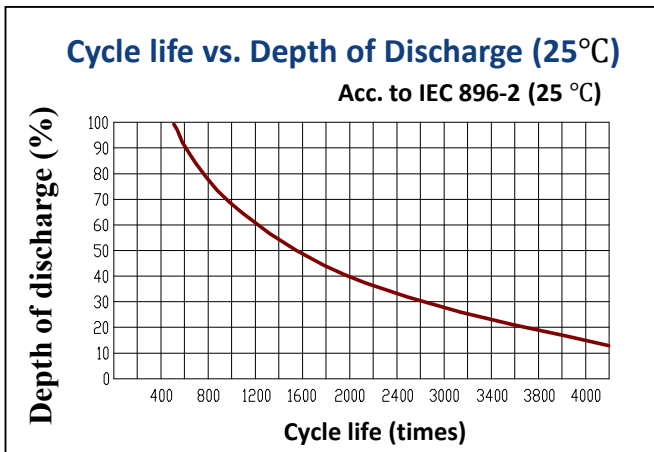
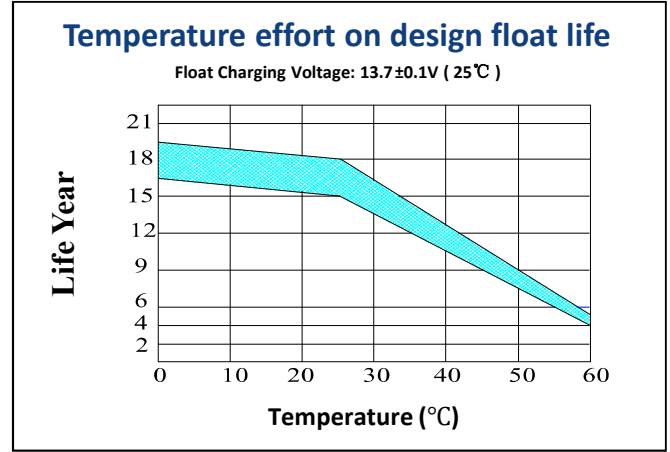
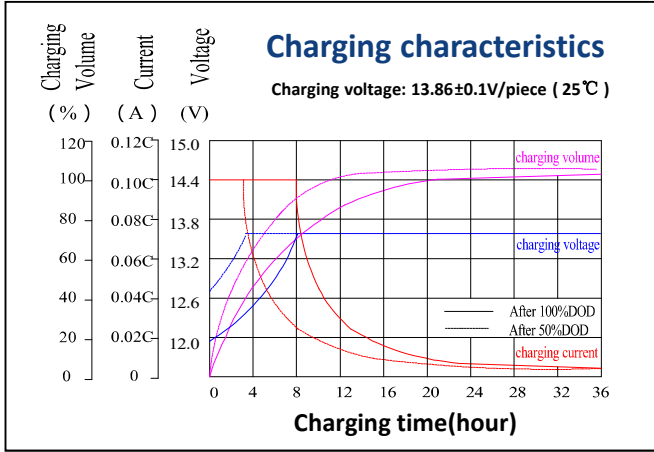

## Battery Construction

Component	Positive Plate	Negative Plate	Container & Cover	Safety Valve	Terminal	Separator	Electrolyte	Pillar Seal
Features	Thick high Sn low Ca grid with special paste	Balanced Pb-Ca grid for improved recombination efficiency	Fire resistant ABS (UL94-V0 optional)	Flame Si-Rubber and aging resistant	Female Copper Insert M6	Advanced AGM separator for high pressure cell design	Silicon Gel	Two layers epoxy resin seal